

Circular Connectors C 16-3 Female cable connector size 2; straight, No. of contacts 12 + PE, 300 V

Part No. C016 10E012 003 2

Series Circular Connectors C 16-3

Subseries Circular Connector C 16-3



View represents all available contact positions.

COMMON CHARACTERISTICS		
No. of contacts		12 + PE
Version		size 2; straight
Cable diameter		12-14
ELECTRICAL CHARACTERISTICS		
Rated voltage	DIN EN 60664-1 / IEC 60664-1	3 x 500 V 9 x 300 V
Rated voltage	UL 1977	3V
Rated impulse voltage	DIN EN 60664-1 / IEC 60664-1	3 x 6000 V 9 x 4000 V
Installation category	DIN EN 60664-1 / IEC 60664-1	III
Insulation group	DIN EN 60664-1 / IEC 60664-1	II
Insulation resistance	DIN EN 60512-2, Test 3a / IEC 60512-2, Test 3a	$\geq 10^8$
Contact resistance	DIN EN 60512-2, Test 2a / IEC 60512-2 Test 2a	≤ 5 m
Current carrying capacity	DIN EN 60512-3, Test 5b / IEC 60512-2 Test 5b	3 x 21 A 9 x 11 A
Pollution degree	DIN EN 60664-1 / IEC 60664-1	3
CLIMATICAL CHARACTERISTICS		
Climatic category	DIN EN 60068-1 / IEC 60068-1	40 / 125 / 56
Operating temperature		-40°C ... +125°C
MECHANICAL CHARACTERISTICS		
IP degree of protection	DIN EN 60529 / IEC 60529	IP 65
Insertion and withdrawal force	DIN EN 60512-13-2, Test 13b / IEC 60512-13-2, Test 13b	≤ 25 N
Mechanical lifetime	DIN EN 60512-9-1, Test 9a	≥ 500 Steckzyklen
Strain relief		Cable retention
MATERIALS		
Contact plating		silver plated / gold plated
Housing		Polyamid 6.6
Gasket		Neoprene
Dielectric material		Polyamid 6.6
FURTHER CHARACTERISTICS		
Termination		crimp
Wire gauge		0,09 - 2,5 mm ²
Wire gauge (AWG)		28 - 14
Flammability	UL 94	V-0
Locking		Bayonet



3964



E63093



48932

Circular Connectors C 16-3 Female cable connector size 2; straight, No. of contacts 12 + PE, 300 V

Part No. C016 10E012 003 2

Series Circular Connectors C 16-3

Subseries Circular Connector C 16-3



View represents all available contact positions.

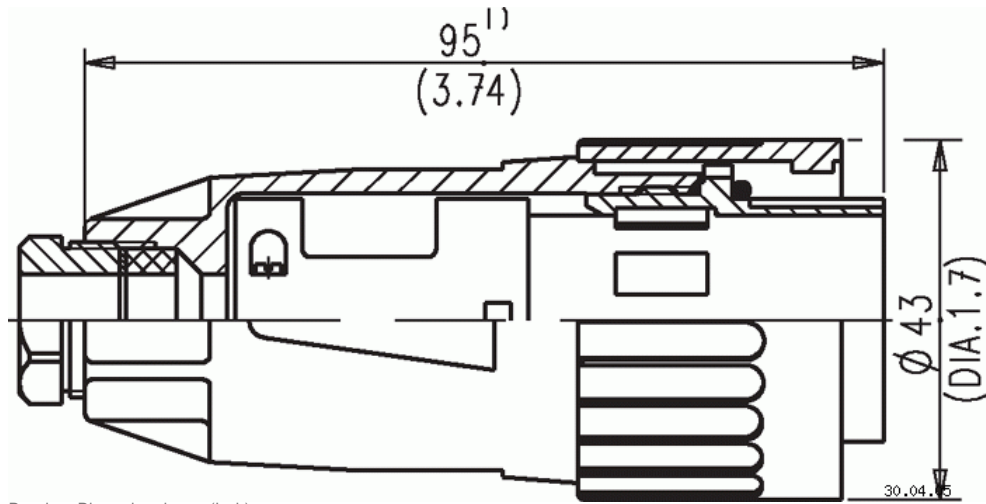

Drawing Dimensions in mm (Inch)

Circular Connectors C 16-3 Female cable connector size 2; straight, No. of contacts 12 + PE, 300 V

Part No. C016 10E012 003 2

Series Circular Connectors C 16-3

Subseries Circular Connector C 16-3



View represents all available contact positions.

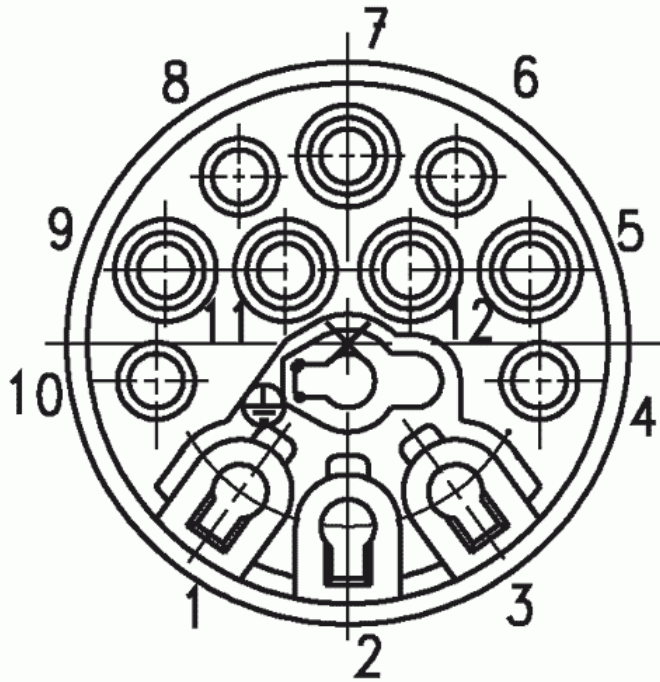

Contact arrangement

30.04.05